

PUISSANCE FOURNIE AU BOÎTIER DE COMMUTATION

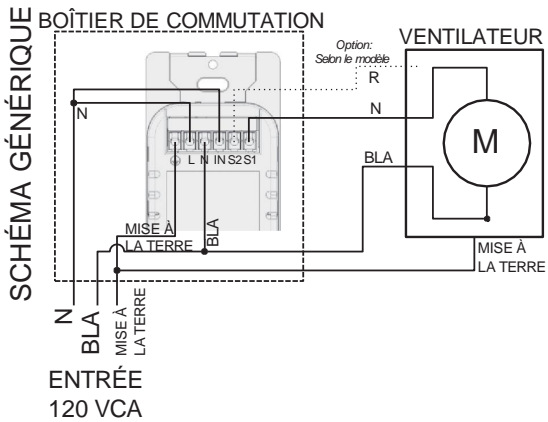

PUISSANCE FOURNIE AU VENTILATEUR

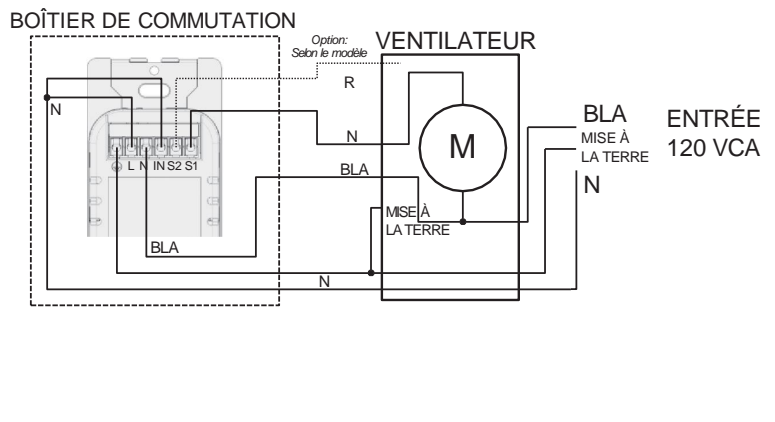

PUISSANCE FOURNIE AU BOÎTIER DE COMMUTATION

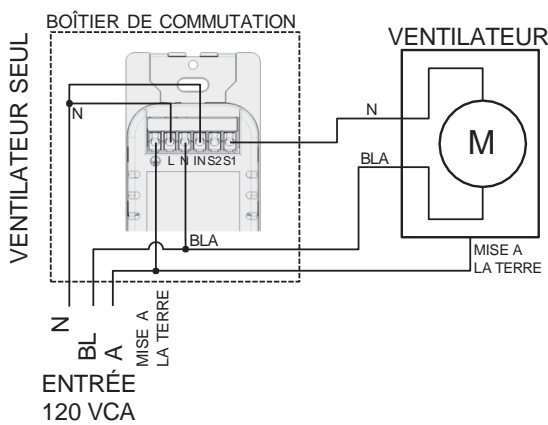

PUISSANCE FOURNIE AU VENTILATEUR

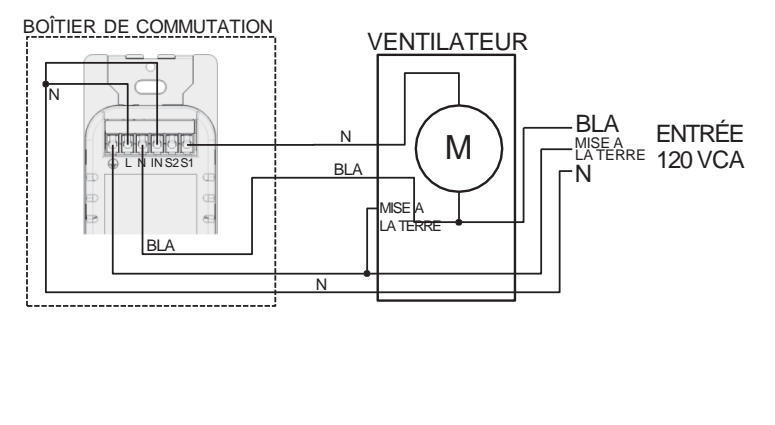

PUISSANCE FOURNIE AU BOÎTIER DE COMMUTATION

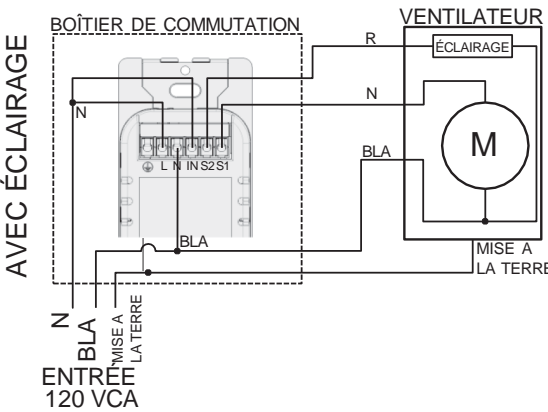

PUISSANCE FOURNIE AU VENTILATEUR

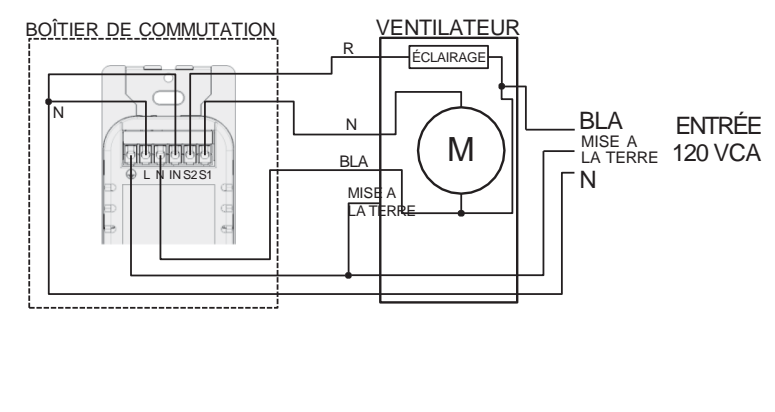

PUISSANCE FOURNIE AU BOÎTIER DE COMMUTATION

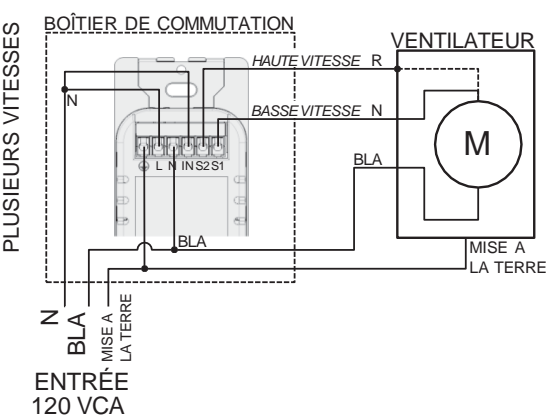

PUISSANCE FOURNIE AU VENTILATEUR

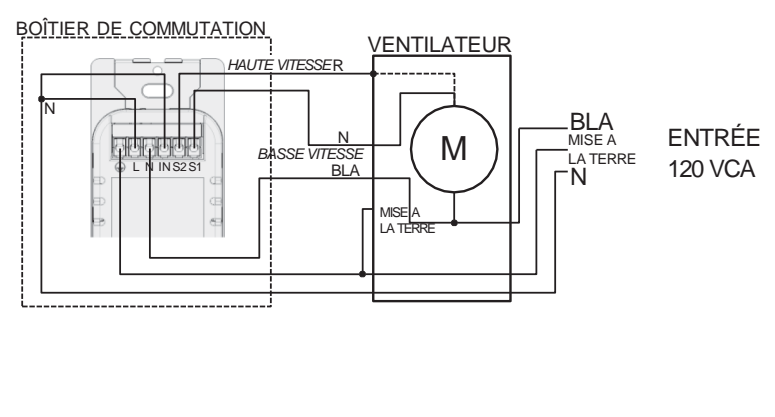

BOÎTIER DE COMMUTATION

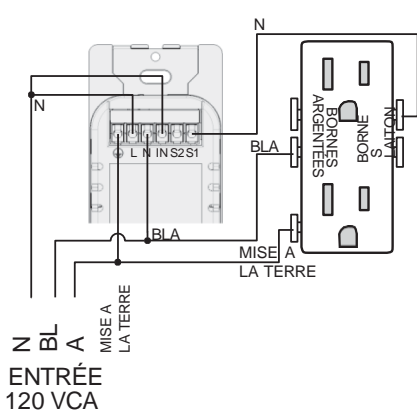

ENERGÍA SUMINISTRADA A LA CAJA DE SECCIONAMIENTO

ENERGÍA SUMINISTRADA AL VENTILADOR

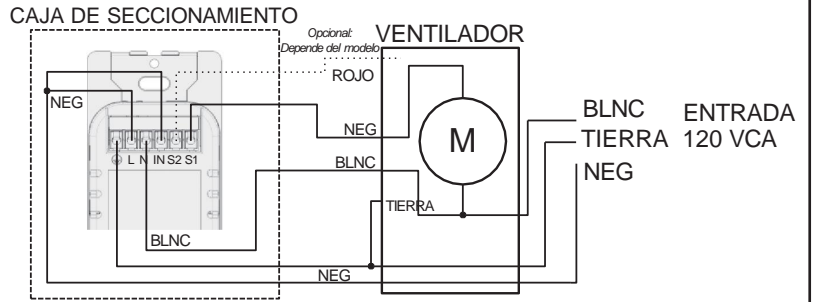
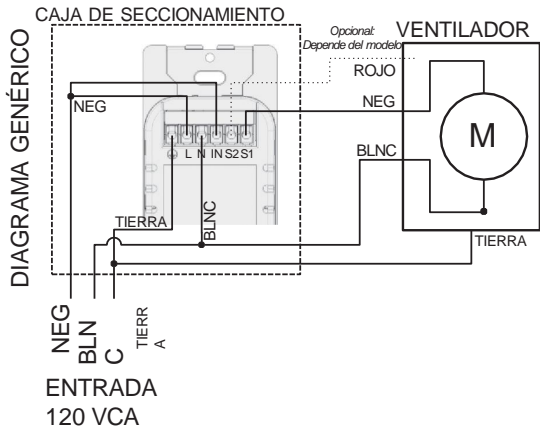

ENERGÍA SUMINISTRADA A LA CAJA DE SECCIONAMIENTO

ENERGÍA SUMINISTRADA AL VENTILADOR

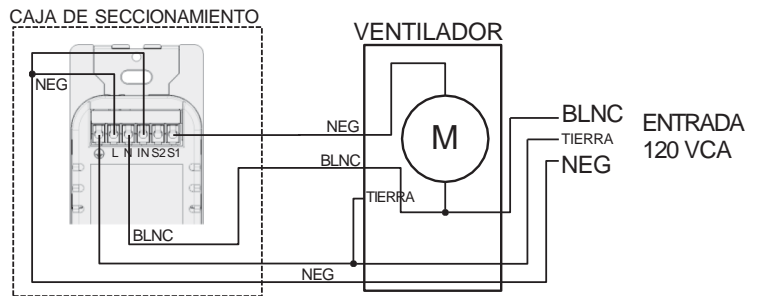
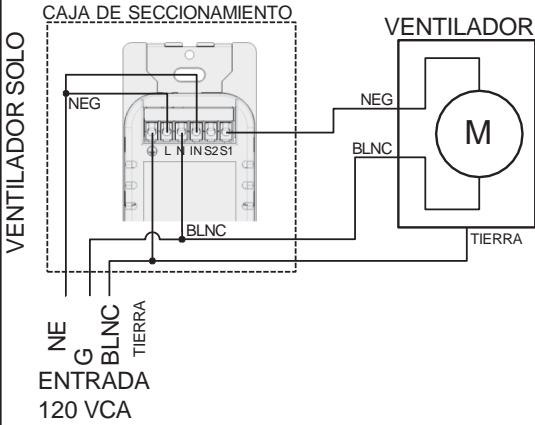

ENERGÍA SUMINISTRADA A LA CAJA DE SECCIONAMIENTO

ENERGÍA SUMINISTRADA AL VENTILADOR

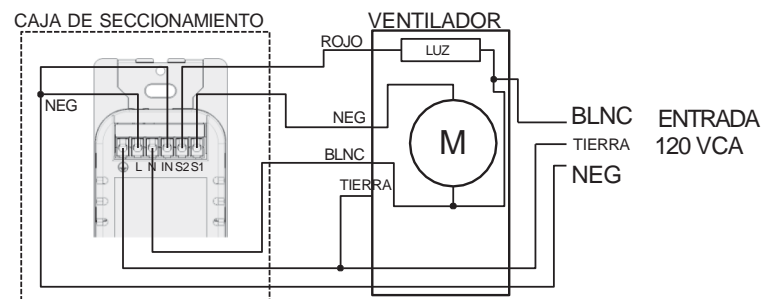
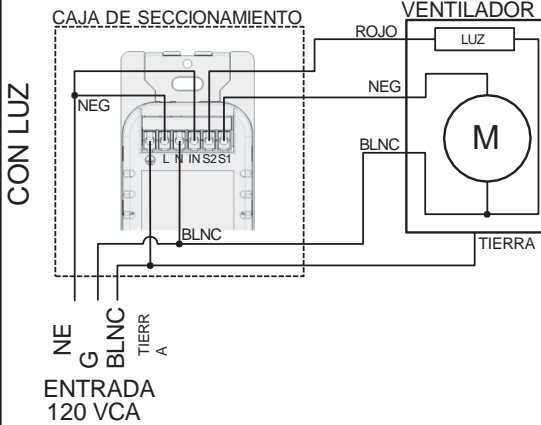

ENERGÍA SUMINISTRADA A LA CAJA DE SECCIONAMIENTO

ENERGÍA SUMINISTRADA AL VENTILADOR

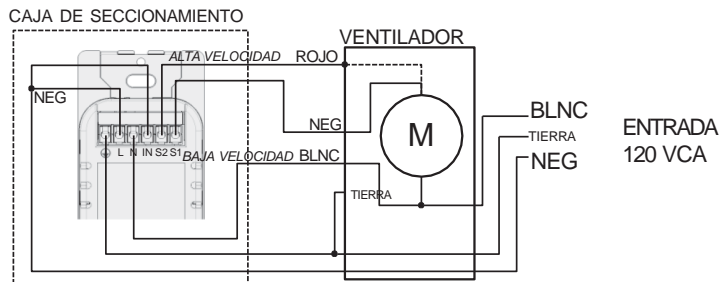
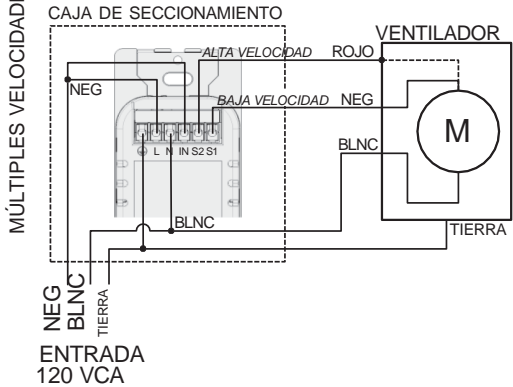

CAJA DE SECCIONAMIENTO

